

Accuphase

CLEAN POWER SUPPLY

PS-500V

- AC voltage stabilizer based on waveform shaping technology
- Superior waveform compensating power
- Excellent current capability
- Highly effective interference rejection
- Built-in meter allows monitoring of output power, input/output voltage, and input/output distortion
- Elaborate protection features
- Large "Super Ring" toroidal transformer





Tap into a totally clean source of AC energy, free from distortion and high-frequency noise. Revolutionary waveform shaping technology enables highly precise compensation, providing a pure energy source with 120 V AC \pm 2% (or 230 V AC \pm 2%). Audio or video equipment with a total power consumption of up to 510 VA can be connected, for a drastic improvement in sound and picture quality. Monitoring of output power, input/output voltage, and input/output distortion is possible.

The PS-500V is a revolutionary product which removes the noise components from the AC power line and improves signal quality by continually monitoring and shaping the power supply waveform. As a result, sound and picture quality of audio and video equipment is drastically improved.

The AC power lines in ordinary homes as well as in office buildings or recording studios invariably suffer from high amounts of noise and waveform distortion. The ideal waveform of the power supply is sinusoidal, but when various electrical devices are connected to the same power source, unwanted voltage fluctuations will occur. In addition, appliances containing digital circuits, such as computers or telephones, emit high-frequency noise components that can enter audio or video components via the power supply and severely affect sound or picture quality by causing intermodulation noise and distortion. Only when such noise interference is removed and totally clean power is supplied are audio and video components able to develop their full potential. This is especially true for high-end equipment. Consequently, upgrading the quality of the AC power source is bound to result in a drastic improvement in the overall performance of your audio/video system.

The PS-500V constantly monitors the input voltage waveform and adds or subtracts exactly the required amount of compensation to achieve a perfectly regular, sinusoidal waveform. The compensation required by this innovative technique typically is only a fraction of overall power. The PS-500V therefore operates with high efficiency and produces little heat, allowing it to be designed as a fairly compact and lightweight unit. Because the output impedance of its AC outlets is extremely low, any combination of components with a total power consumption of 510 VA maximum can be connected. Since it contains no oscillators or switching circuitry, the PS-500V itself does not act as a source of spurious high-frequency noise.

AC Voltage Stabilizer Based on Waveform Shaping Technology

The PS-500V accepts AC power on the input side,

Power supply waveform and PS-500V output waveform

Almost every electrical device used in an household converts the AC supplied by the outlet into DC current for powering its internal circuits. This task is performed by a rectifier. As shown in photograph (A), the rectifier load current has a large current flowing momentarily in the vicinity of the voltage peak.

This causes a voltage drop, resulting in clipping of the voltage waveform, as shown in photograph (B). A clipped waveform with a high amount of distortion contains many unwanted frequency components, or harmonics. When entering the audio circuitry of an amplifier through the power supply, such harmonic components can interfere with the audio signal and cause intermodulation distortion, which has a highly detrimental effect on sound quality.

When passing through the PS-500V, the deformed waveform is restored to its original sine wave pattern, as shown in photograph (C).

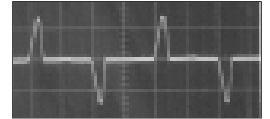

Photo (A) Current waveform of rectified load

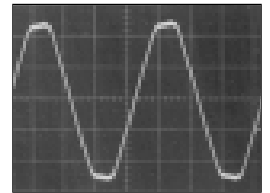

Photo (B) Voltage waveform of AC line (distortion approx. 3%)

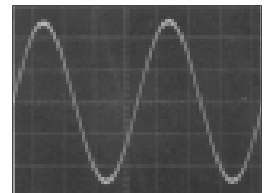
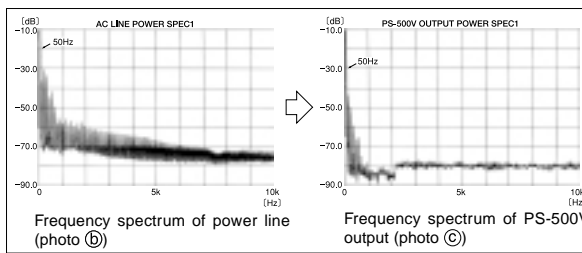

Photo (C) PS-500V output waveform (distortion approx. 0.2%)



Frequency spectrum of power line

processes it using internal control circuitry, and supplies it as clean AC power on the output side. Most of the AC energy from the input is carried over to the output. The loss introduced by the PS-500V is very small, since it consists only of the power required for waveform compensation. Compared to conventional AC voltage stabilizers, efficiency is much higher and excess thermal energy is low, allowing the unit to be made relatively small and lightweight. Since the power supply frequency is synchronized to the input, an internal oscillator is not required. Therefore the unit

itself does not generate any high-frequency noise.

Figure 1 shows a block diagram of the unit. The signal from the secondary winding S₁ of the transformer reaches the adding/subtracting circuit and appears at the output as output voltage (e_o). A part of the output voltage is routed to the - input of the waveform comparator for waveform comparison. The S₂ signal from the transformer goes to the reference waveform generating circuit where it becomes the high-precision sine waveform (e_i) synchronized to the input frequency of 50/60 Hz. This sine wave signal is then routed to the + input of the waveform comparator to be used as the reference signal. By comparing the two input signals, a differential component is extracted. Based on this information, the adding/subtracting circuit can provide exactly the required amount of compensation for turning the output into a high-precision sine waveform.

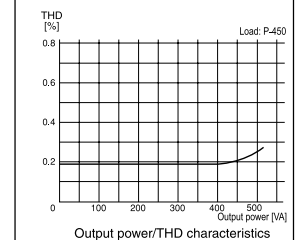
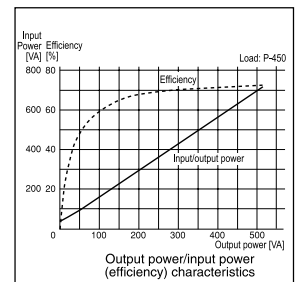

Fig. 2 PS-500V Load Characteristics

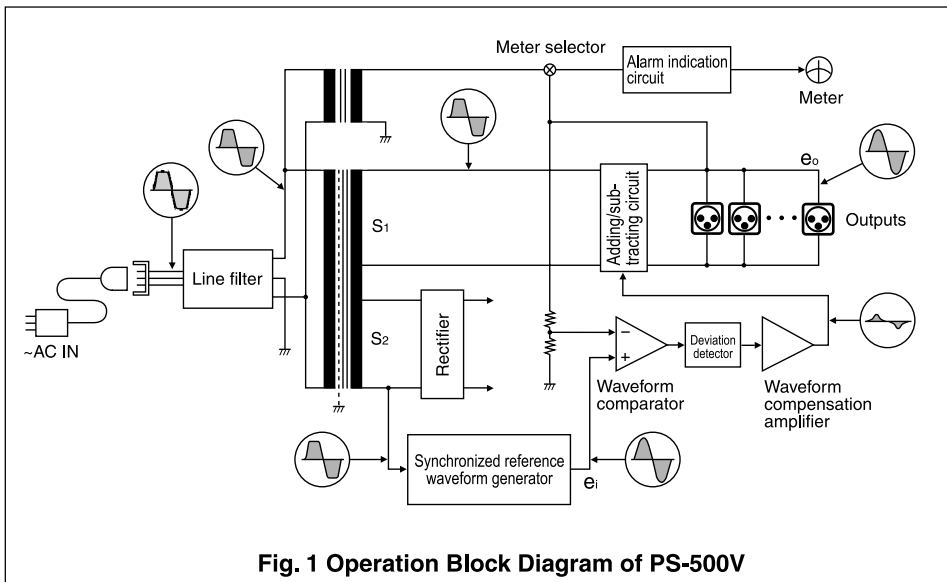
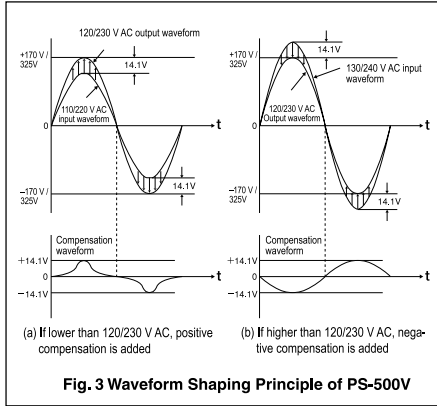

Fig. 1 Operation Block Diagram of PS-500V

Superior Waveform Compensating Power

When the input voltage is 110 V (220 V), the voltage at the secondary side of the transformer will also be 110 V (220 V). To bring this to 120 V (230 V), 10 volts must be added, as shown in Figure 3 (a). Conversely,



if the input is 130 V (240 V), 10 volts must be subtracted to yield 120 V (230 V), as shown in Figure 3 (b). In actual operation, the peak value of 10 V, namely 14.1 V is added or subtracted.

Comparing a precise sine wave synchronized to the input frequency with the output voltage yields a compensation waveform which is imposed on the output voltage. Consequently, for an input voltage range of 108-132 V AC (200-253 V AC) and a constant load of 510 W, the output voltage is kept constant at 120 V $\pm 2\%$ (230 V $\pm 2\%$), with a maximum distortion ratio of 0.3%. These values demonstrate the outstanding waveform compensation ability of the PS-500V.

Note: The above explanation is for the 120 V AC version of the PS-500V. Figures in brackets refer to the 230 V AC version.

Highly Effective Interference Rejection

The input side of the PS-500V is equipped with a line filter for

removing any high-frequency noise components present in the power line, such as generated by digital equipment. The primary and secondary windings of the power transformer are kept totally separate, and the fully shielded design shuts out any externally induced noise.

Since the PS-500V uses the AC feedback principle, output impedance is extremely low. This prevents any possibility of mutual interference between components connected to the outputs of the PS-500V.

Built-in Meter Allows Monitoring of Output Power, Input/Output Voltage, Input/Output Distortion. Overload Is Indicated by Flashing Meter Illumination.

The meter of the PS-500V lets the user see at a glance how much power (VA) the connected equipment is consuming at any given time. This is especially helpful for components such as integrated amplifiers or power amplifiers whose power consumption differs considerably depending on the volume setting and actual music signal. The maximum output power rating of the unit is 510 VA. When this is exceeded, the meter illumination flashes as a warning indication.

Excellent Current Capability

The power amplifier which performs waveform compensation is configured as a pure complementary symmetrical circuit using current feedback for

unsurpassed operation stability. The output stage uses transistors rated for a maximum current of 10 amperes. These devices are connected in a 10-parallel complementary push-pull arrangement, which boasts excellent current capability.



Assembly with input voltage/distortion monitoring circuitry

Elaborate Protection Features Assure Total Operation Safety

When a problem occurs during operation, the circuit breaker integrated in the power switch immediately shuts off the power, to protect the unit and any connected components.



Assembly with protection circuitry

- Assembly with output stage with 10-parallel push-pull multi-emitter devices mounted to large heat sink, waveform compensation amplifier for addition/subtraction, comparator for reference waveform and output waveform, deviation detector, etc.



- ① If an input current overload occurs, such as when the output is short-circuited, the power is shut off.
- ② In case of momentary power overload, such as caused by inrush current when a component is switched on or when a power amplifier reproduces a peak passage in the music, a current limiter goes into action. For the 120 V version, the maximum current is 60 A and for the 230 V version it is 30 A.
- ③ When DC voltage is detected in the output or when the output voltage exceeds the maximum rating, the output is switched off to protect connected components.
- ④ When the temperature of the internal heat sink or power transformer exceeds 110°C, the circuitry is automatically switched off.

Strong Power Supply With Large "Super Ring" Toroidal Transformer and High Filtering Capacity

The power transformer plays a vital role in any power supply. The PS-500V uses a large toroidal type rated

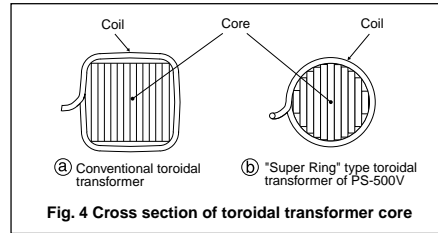

Fig. 4 Cross section of toroidal transformer core

for 750 VA. Toroidal power transformers have large-gauge copper wiring on a donut-shaped core, resulting in very low impedance, high efficiency, and compact dimensions.

Multiple Output Connectors

The PS-500V can supply a number of components such as a CD player, DAT recorder, preamplifier, power amplifier or other audio or video components, provided the combined power consumption is less than 510 VA.

Power Meter Indication and Load

The power consumption of electrical equipment, as indicated on the equipment itself and in catalogs and other documentation, is usually given in watts (W). This figure represents the so-called effective power which is stated according to legal requirements. However, the actual power drawn by the equipment is larger than the effective power. This is called the apparent power which is calculated by multiplying the applied voltage with the actual current. The unit for apparent power is VA (volt-ampere). Since the value shown by the power meter of the PS-500V in the "VOLT-AMPERE" position is the apparent power, the reading will be higher than the power consumption (W) given in catalogs and specification sheets.

- The rated power limit of the PS-500V is 510 VA. When deciding on equipment to be connected, power consumption figures given in catalogs and the like can be used for a general estimate, but actual power consumption should be checked using the meter.
- The power consumption of integrated amplifiers and power amplifiers varies considerably depending on the actual audio output. After connecting such equipment, perform playback and verify that power consumption does not exceed 510 VA when peaks in the music are reproduced at high volume levels.
- In case of overload, the meter illumination flashes. Reduce the load by reducing the number of connected components until the illumination stops flashing and stays constantly lit.
- For reference, some Accuphase products are listed shown below.

Can be connected:
Preamplifiers, CD players, tuners and other low-power components E-407, E-306V, E-211, A-20V

Can be connected at normal volume settings (*):
P-1000, P-700, P-550, P-450

Cannot be connected
A-50, A-50V

(*) When driving loudspeakers with an impedance of about 8 ohms to normal listening levels

PS-500V Guaranteed Specifications

| | 120 V version | 230 V version |
|--------------------------------------------|---------------------------------------------------------------------------|----------------------|
| Rated output capacity | 510 VA (continuous) | |
| Rated output voltage | 120 V AC ± 2.4 V | 230 V AC ± 4.6 V |
| Rated output current | 4.2 A | 2.2 A |
| Output frequency | 50 Hz or 60 Hz (identical to input frequency) | |
| Instantaneous peak current capacity | 60 A | 30 A |
| Output waveform THD | 0.3% or less | |
| Rated input voltage | 120 V AC | 230 V AC |
| Input frequency | 50 Hz or 60 Hz | |
| No-load power consumption | 55 W | |
| Cooling principle | Natural air cooling | |
| Meter | 0 - 510 VA The meter illumination flashes when an overload occurs | |
| VOLT-AMPERE | The meter illumination flashes when an overload occurs | |
| VOLTAGE INPUT/OUTPUT (green zone of scale) | 120 V AC $\pm 5\%$ | 230 V AC $\pm 5\%$ |
| DISTORTION INPUT/OUTPUT | 0 - 6% | |
| Dimensions | 475 mm (18-11/16") width, 180 mm (7-1/16") height, 394 mm (15-1/2") depth | |
| Weight | 23.8 kg (52.5 lbs.) net 27.0 kg (59.5 lbs.) in shipping carton | |

FRONT PANEL

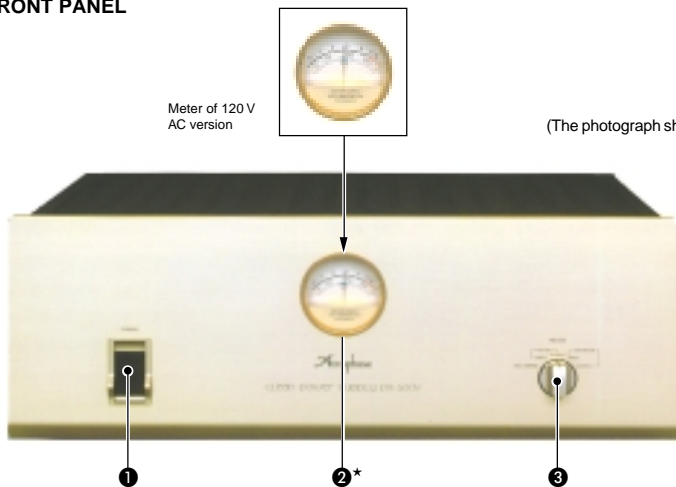

- ① Power switch/circuit protector
- ② Meter (Output power, input/output voltage, input/output distortion)*
- ③ Meter operation selector
VOLT-AMPERE VOLTAGE INPUT/OUTPUT DISTORTION INPUT/OUTPUT

REAR PANEL

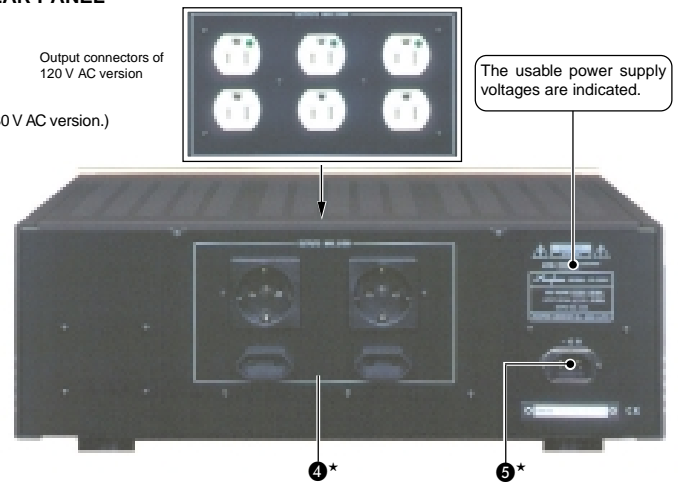

- ④ Output connectors (AC outlets)*
- ⑤ Power connector (for supplied power cord)*

Remark

★ The 120 V AC and 230 V AC versions of the PS-500V differ regarding meter voltage indication, AC output connector shape, supplied power cord, etc. Make sure that you have the correct version.



Caution

* The PS-500V is available in a 120 V AC and 230 V AC version. The actual allowable voltage is indicated besides the AC power connectors on the rear panel. Be sure to check this indication before using the PS-500V.
* This product can be used only on a regular household AC circuit rated for 120 V or 230 V AC. Using the product with portable AC generators, airplane or ship power generators or other types of power sources is not possible.
* This product is designed to improve the quality of AC power supplied to audio or video components. Do not use it to power industrial type equipment or common household electrical appliances.

● Specifications and design subject to change without notice for improvements.

